

FRC-MAR

RETURN FILTERS



MATERIALS

Head : Aluminium alloy
Spin-on cartridge: Steel
Bypass valve: Polyammide
Seals: NBR Nitrile
Indicator housing: Brass

PRESSURE

Max. working: 700 kPa (7 bar)
Collapse, differential for the filter element (ISO 2941):
300 kPa (3 bar)

BYPASS VALVE

Setting: 170 kPa (1,7 bar) \pm 10%

WORKING TEMPERATURE

From -25° to +110° C

COMPATIBILITY (ISO 2943)

Full with fluids: HH-HL-HM-HV-HTG
(according to ISO 6743/4)
For fluids different than the above mentioned,
please contact our Customer Service.



HYDRAULIC DIAGRAM

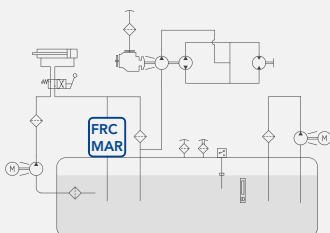

Is this datasheet the latest release? Please check on our website.



ORDERING AND OPTION CHART

F	R	C	COMPLETE FILTER FAMILY					FILTER ELEMENT FAMILY	E	R	C
			SIZE & LENGHT	11	12	21	22	SIZE & LENGHT			
		B	PORT TYPE								
			B = BSP thread	B	B	B	B				
			PORT SIZE								
			06 = 3/4"	06	06	-	-				
			12 = 1"1/2"	-	-	12	12				
		B	BYPASS VALVE								
			B = 170 kPa (1,7 bar) with anti-drain membrane	B	B	B	B				
		N	SEALS					SEALS		N	
			N = NBR Nitrile	N	N	N	N				
			FILTER MEDIA					FILTER MEDIA			
			FB = fibreglass 7 µm(c) β>1.000	FB	FB	FB	FB				
			FC = fibreglass 12 µm(c) β>1.000	FC	FC	FC	FC				
			FD = fibreglass 21 µm(c) β>1.000	FD	FD	FD	FD				
			CC = impregnated cellulose 10 µm β>2	CC	CC	CC	CC				
			CD = impregnated cellulose 25 µm β>2	CD	CD	CD	CD				
			CLOGGING INDICATOR								
			05 = nr. 2 x 1/8" ports, plugged	05	05	05	05				
			30 = pressure gauge, rear connection	30	30	30	30				
			P1 = SPDT pressure switch	P1	P1	P1	P1				
X	X		ACCESSORIES								
			XX = no accessory available	XX	XX	XX	XX				

SPARE PARTS ELEMENTS

FILTER HOUSING				FILTER ELEMENT				CLOGGING INDICATOR				
B	R	C		B		B	N				X	X
				E	R	C		N				



MAR

RETURN FILTERS

ORDERING AND OPTION CHART

M	A	R	COMPLETE FILTER FAMILY					FILTER ELEMENT FAMILY	C	C	A
			SIZE & LENGHT	151	152	301	302	SIZE & LENGHT			
			FILTER MEDIA					FILTER MEDIA			
			FT = fibreglass 5 µm(c) β>1.000	FT	FT	FT	FT				
			FC = fibreglass 7 µm(c) β>1.000	FC	FC	FC	FC				
			FD = fibreglass 12 µm(c) β>1.000	FD	FD	FD	FD				
			FV = fibreglass 21 µm(c) β>1.000	FV	FV	FV	FV				
			CD = impregnated cellulose 10 µm β>2	CD	CD	CD	CD				
			CV = impregnated cellulose 25 µm β>2	CV	CV	CV	CV				
1			SEALS					SEALS	1		
			1 = NBR Nitrile	1	1	1	1				
M			BYPASS VALVE								
			M = 170 kPa (1,7 bar) with anti-drain membrane	M	M	M	M				
B			PORTS								
			B = BSP thread	B	B	B	B				
			PORT SIZE								
			4 = 3/4"	4	4	-	-				
			7 = 1" 1/2	-	-	7	7				
			CLOGGING INDICATOR								
			05 = nr. 2 x 1/8" ports, plugged	05	05	05	05				
			30 = pressure gauge, rear connection	30	30	30	30				
			P1 = SPDT pressure switch	P1	P1	P1	P1				
			ACCESSORIES								
			XX = no accessory available	XX	XX	XX	XX				

SPARE SEAL KIT

NBR

FRC11 MAR151	521.0018.2
FRC12 MAR152	521.0018.2
FRC21 MAR301	521.0036.2
FRC22 MAR302	521.0036.2

FRC-MAR

RETURN FILTERS



INSTALLATION DRAWING

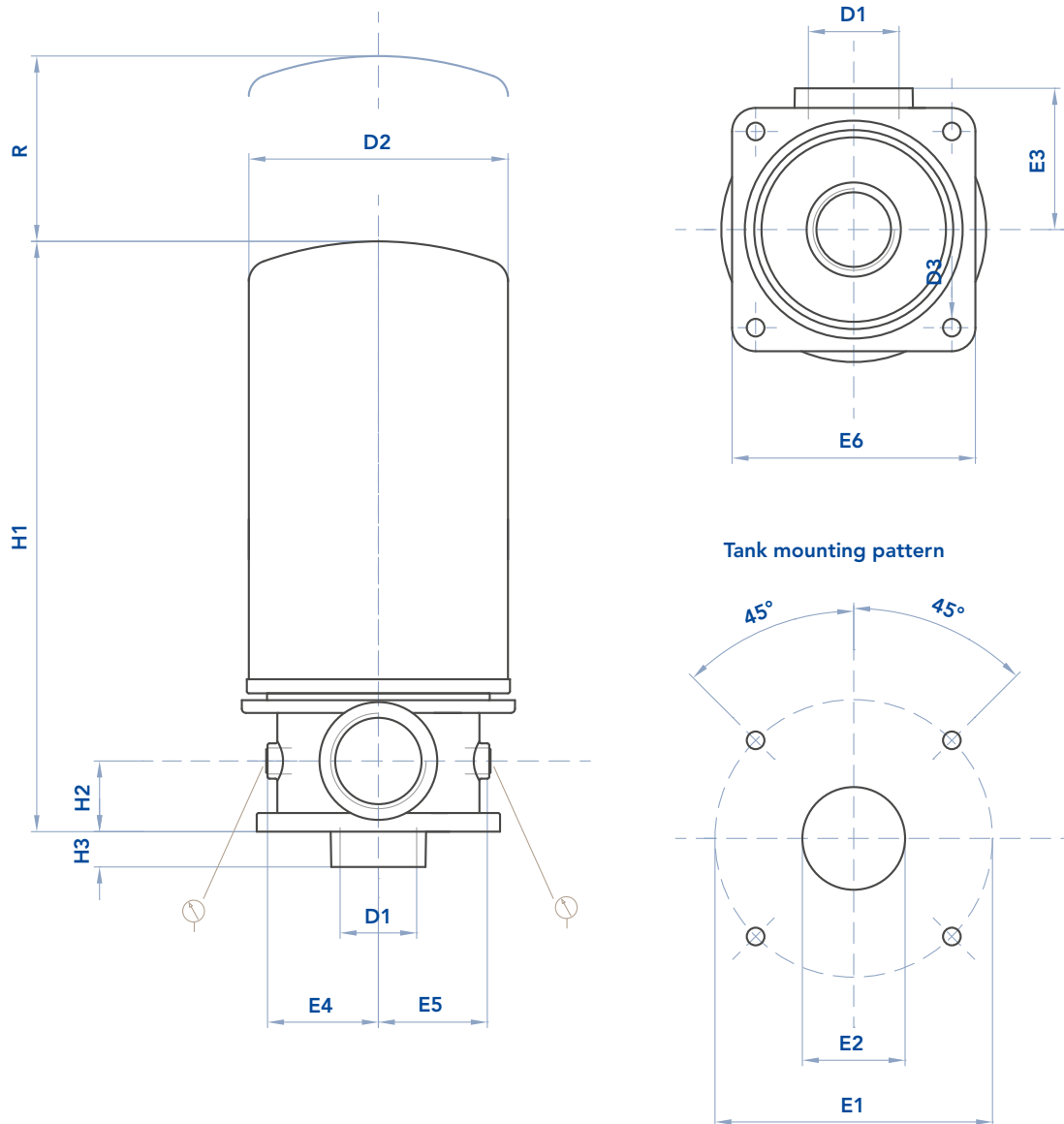

FILTER HOUSING

	D1	D2	D3	H1	H2	H3	E1	E2	E3	E4	E5	E6	R	Kg
FRC11 MAR151	3/4"	96	7	196	25	18	99	40÷45	50	38	38	90	15	1,3
FRC12 MAR152	3/4"	96	7	241	25	18	99	40÷45	50	38	38	90	15	1,6
FRC21 MAR301	1"1/2	129	9	252	36	18	141	65÷70	72	56	56	124	30	2,1
FRC22 MAR302	1"1/2	129	9	297	36	18	141	65÷70	72	56	56	124	30	2,2

FRC-MAR

RETURN FILTERS



MAINTENANCE

The best time to change your filter element is just before it reaches its maximum dirt-holding capacity. For this reason, we recommend to monitor the pressure of the hydraulic oil flowing through the filter with a clogging indicator. When it is time to change the filter element, switch off the system. Remove the dirty filter element. Replace it with

an original UFI element, verifying the part number on the filter label or on the catalogue. Lubricate the spin-on gasket, screw on the head until it stops and tighten by turning it 3/4 of a turn.

We recommend the stocking of a spare UFI filter element for timely replacement when required.

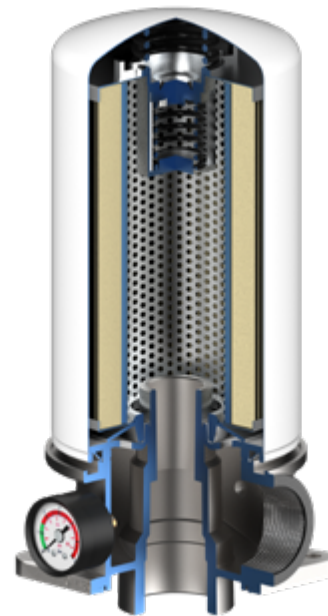
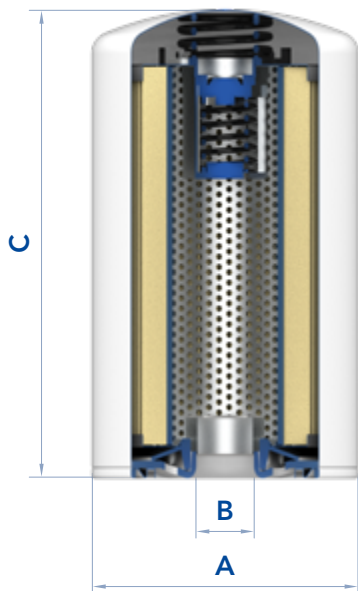

FILTER ELEMENT

	A	B	C	Kg	AREA (cm ²)	
					Media F+	Media C+
ERC11 CCA151...M	96,5	3/4" BSP	146	1,00	2.140	3.305
ERC12 CCA152...M	96,5	3/4" BSP	191	1,20	3.630	4.745
ERC21 CCA301...M	129	1"1/4 BSP	181	1,40	4.450	5.560
ERC22 CCA302...M	129	1"1/4 BSP	226	1,50	5.890	7.360

The used filter elements cannot be cleaned and are classified as "Dangerous waste material". They must be disposed according to local laws by authorized Companies.

Verify that the Company you choose has the expertise and authorization to dispose this type of waste material.

FRC-MAR

RETURN FILTERS



PRESSURE DROP CURVES (ΔP)

The "Assembly Pressure Drop (Δp)" is obtained by adding the pressure drop values of the Filter Housing and of the Clean Filter Element corresponding to the considered Flow Rate and it must

be lower than 50 kPa (0,5 bar) and should never exceed 1/3 of the bypass valve setting.

FILTER HOUSING PRESSURE DROP
(mainly depending on the port size)

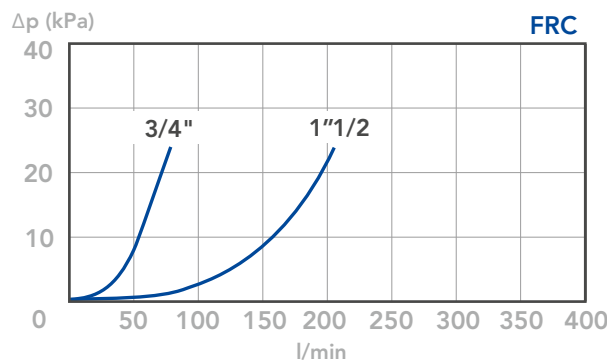

CLEAN FILTER ELEMENT PRESSURE DROP WITH F+ AND C+ MEDIA
(depending both on the internal diameter of the element and on the filter media)

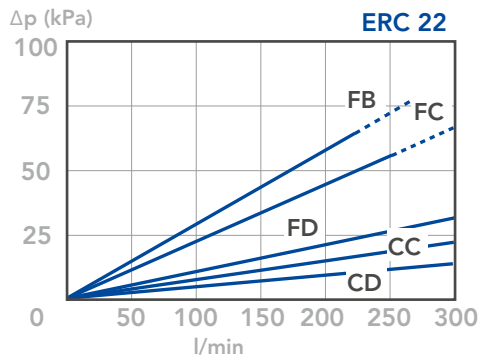
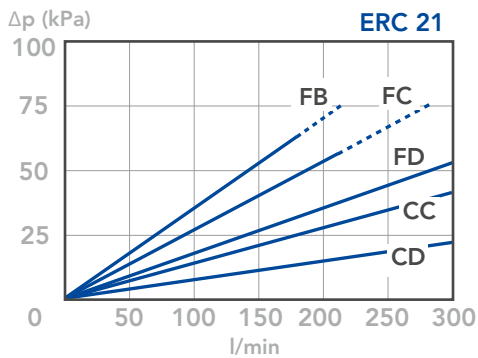
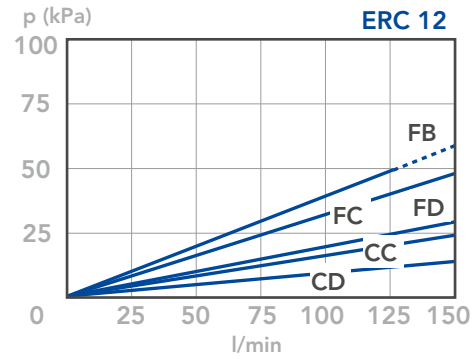
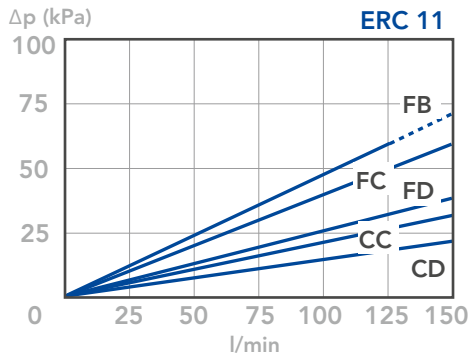

FRC-MAR

RETURN FILTERS



BYPASS VALVE PRESSURE DROP

When selecting the filter size, these curves must be taken into account if it is foreseen that any flow peak is to be absorbed by the bypass valve, it also must be of proper configuration to avoid pressure peaks. The valve pressure drop is directly proportional to fluid specific gravity.

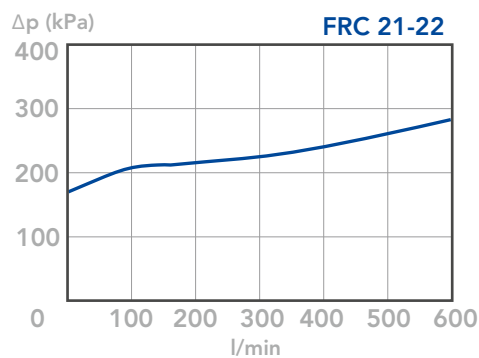
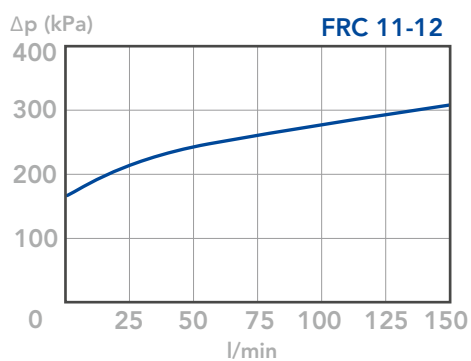

N.B.

All the curves have been obtained with mineral oil having a kinematic viscosity 30 cSt and specific gravity 0,86 Kg/dm³; for fluids with different features, please consider the factors described in the first part of this catalogue. All the curves

are obtained from test done at the UFI HYDRAULIC DIVISION Laboratory, according to the specification ISO 3968. In case of discrepancy, please check the contamination level, viscosity and features of the fluid in use.