

# FSD-MSE

## SUCTION FILTERS



### MATERIALS

Cover & housing: Anodized aluminium alloy  
For 61&62 only: Cover: anodized aluminium alloy  
Housing: steel  
Bypass valve: Polyamide  
Seals: NBR Nitrile (FKM on request fluoroelastomer)  
Indicator housing: Brass

### PRESSURE

Collapse, differential for filter element (ISO 2941): 1 MPa (10 bar)

### WORKING TEMPERATURE

From -25° to +110° C

### COMPATIBILITY (ISO 2943)

Full with fluids: HH-HL-HM-HV-HTG  
(according to ISO 6743/4)  
For fluids different than the above mentioned,  
please contact our Customer Service.



### HYDRAULIC DIAGRAM

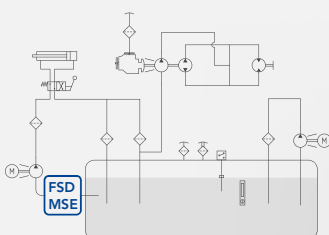

Is this datasheet the latest release? Please check on our website.



# FSD

## SUCTION FILTERS



### ORDERING AND OPTION CHART

F	S	D	COMPLETE FILTER FAMILY						FILTER ELEMENT FAMILY	E	R	D	
			SIZE & LENGHT	11	21	31	41	51	61	62	SIZE & LENGHT		
			PORT TYPE										
			B = BSP thread	B	B	B	B	B	-	-			
			N = NPT thread	N	N	N	N	N	-	-			
			S = SAE thread	S	S	S	S	S	-	-			
			F = SAE flange 3000 psi	-	-	F	F	F	F	F			
			PORT SIZE										
			04 = 1/2"	04	-	-	-	-	-	-			
			06 = 3/4"	-	06	-	-	-	-	-			
			08 = 1"	-	-	08	-	-	-	-			
			12 = 1" 1/2 (B12-N12 only)	-	-	-	12	-	-	-			
			20 = 2" 1/2 (B20-F20 only)	-	-	-	-	20	-	-			
			28 = 3" 1/2	-	-	-	-	-	28	-			
			32 = 4"	-	-	-	-	-	-	32			
			BYPASS VALVE										
			W = no bypass	W	W	W	W	W	W	W			
			A = 35 kPa (0,35 bar)	A	A	A	A	A	A	A			
			SEALS										
			N = NBR Nitrile	N	N	N	N	N	N	N	SEALS		
			F = FKM Fluoroelastomer	F	F	F	F	F	F	F			
			FILTER MEDIA										
			ME = metal wire mesh 60 µm	ME	ME	ME	ME	ME	ME	ME	FILTER MEDIA		
			MF = metal wire mesh 90 µm	MF	MF	MF	MF	MF	MF	MF			
			MG = metal wire mesh 250 µm	MG	MG	MG	MG	MG	MG	MG			
			CLOGGING INDICATOR										
			08 = 1/8" seat , plugged	08	08	08	08	08	08	08			
			11 = vacuum gauge, bottom connection	11	11	11	11	11	11	11			
			91 = SPDT, vacuum switch	91	91	91	91	91	91	91			
X	X		ACCESSORIES										
			XX = no accessory available	XX	XX	XX	XX	XX	XX	XX	XX	XX	

### SPARE PARTS ELEMENTS

FILTER HOUSING				FILTER ELEMENT				CLOGGING INDICATOR			
B	S	D		E	R	D					



# MSE

## SUCTION FILTERS



### ORDERING AND OPTION CHART

M	S	E	COMPLETE FILTER FAMILY							FILTER ELEMENT FAMILY	C	R	H
			SIZE & LENGHT	008	015	025	070	150	250	SIZE & LENGHT			
			FILTER MEDIA							FILTER MEDIA			
			MS = metal wire mesh 60 µm	MS	MS	MS	MS	MS	MS				
			MN =metal wire mesh 90 µm	MN	MN	MN	MN	MN	MN				
			DC =metal wire mesh 250 µm	DC	DC	DC	DC	DC	DC				
			SEALS							SEALS			
			1 = NBR Nitrile	1	1	1	1	1	1				
			2 = FKM Fluoroelastomer	2	2	2	2	2	2				
			BYPASS VALVE										
			S = without	S	S	S	S	S	S				
			A = 35 kPa (0,35 bar)	A	A	A	A	A	A				
			PORT TYPE										
			B = BSP thread	B	B	B	B	B	-				
			N = NPT thread	N	N	N	N	N	-				
			S = SAE thread	S	S	S	S	S	-				
			F = SAE flange 3000 psi	-	-	F	F	F	F				
			PORT SIZE										
			3 = 1/2"	3	-	-	-	-	-				
			4 = 3/4"	-	4	-	-	-	-				
			5 = 1"	-	-	5	-	-	-				
			7 = 1"1/2	-	-	-	7	-	-				
			9 = 2"1/2	-	-	-	-	9	-				
			B = 3"1/2	-	-	-	-	-	B				
			CLOGGING INDICATOR										
			08 = 1/8" port, plugged	08	08	08	08	08	08				
			11 = vacuum gauge, bottom connection	11	11	11	11	11	11				
			91 = SPDT, vacuum switch	91	91	91	91	91	91				
X	X		ACCESSORIES										
			XX = no accessory available	XX	XX	XX	XX	XX	XX				

### SPARE SEAL KIT

	NBR	FKM
FSD11 MSE008	521.0045.2	521.0050.2
FSD21 MSE015	521.0046.2	521.0051.2
FSD31 MSE025	521.0047.2	521.0052.2
FSD41 MSE070	521.0031.2	521.0019.2
FSD51 MSE150	521.0048.2	521.0053.2
FSD61 MSE250	521.0049.2	521.0054.2
FSD62	521.0049.2	521.0094.2

# FSD-MSE

## SUCTION FILTERS



### INSTALLATION DRAWING

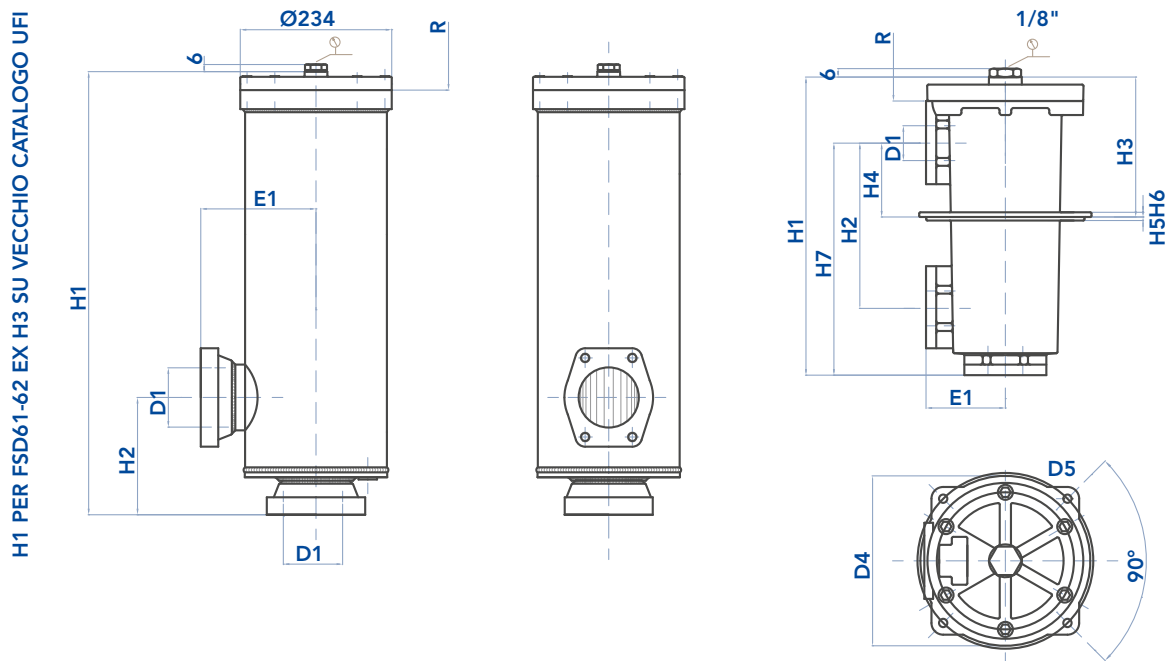

### TANK MOUNTING PATTERN

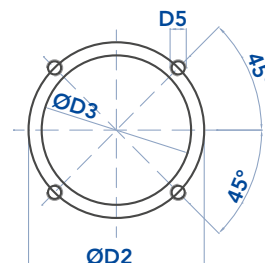

### FILTER HOUSING

	D1	D2	D3	D4	D5	E1	H1	H2	H3	H4	H5	H6	R	Kg
FSD11 MSE008	1/2"	95	85	90	M5	43	160	62,5	96	31,5	4	3	105	1,3
FSD21 MSE015	3/4"	138	123	128	M6	57	191	105	100	52	6	3	110	2,6
FSD31 MSE025	1"	154	137	147	M6	67	250	140	117	63	8	4	155	3,7
FSD41 MSE070	1"1/2	180	164	174	M8	82	323	177	155	82	8	4	240	6,5
FSD51 MSE150	2"1/2	275	239	254	M10	117,5	420	218	192	91	10	8	275	14,2
FSD61 MSE250	3"1/2	-	-	-	-	178	1.130	200	673	457	-	-	525	49,0
FSD62	4"	-	-	-	-	178	1.590	200	1.110	480	-	-	1.020	75,0

# FSD-MSE

## SUCTION FILTERS



### MAINTENANCE

The best time to change your filter element is just before it reaches its maximum dirt-holding capacity. For this reason, we recommend to monitor the pressure of the hydraulic oil flowing through the filter with a clogging indicator. When it is time to change the filter element, switch off the system.

Unscrew the cover and remove it. If the filter has a by-pass valve, don't touch it.

Remove the dirty filter element using the upper handle. Replace it with an original UFI element, verifying the part number on the filter label or on the catalogue. Lubricate the gaskets for an optimal assembly. Position the cover carefully to ensure the seal on the filter element. Tighten the screws with the washers until it stops.

We recommend the stocking of a spare UFI filter element for timely replacement when required.

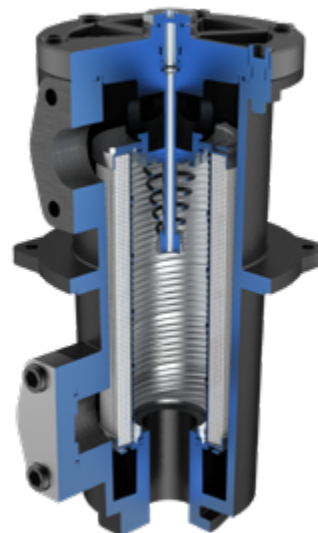
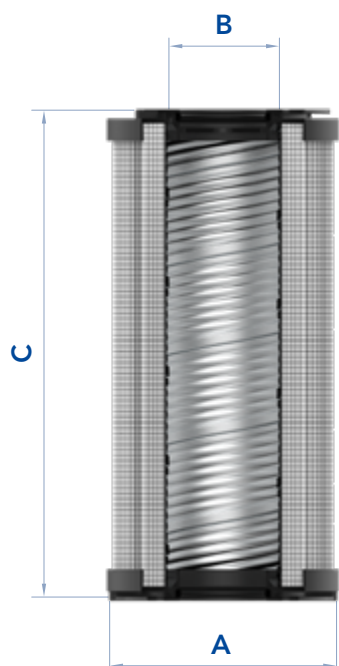

### FILTER ELEMENT

				AREA (cm <sup>2</sup> )	
	A	B	C	KG	Media M+
ERD11 CRH008	52	28/24	70	0,10	245
ERD21 CRH015	70	34	85	0,20	460
ERD31 CRH025	70	34	130	0,25	740
ERD41 CRH070	99	51	211	0,70	2.330
ERD51 CRH150	130	74	251	1,50	3.340
ERD61 CRH250	130	74/85	500	2,00	9.860
ERD62	143	96,3	896	3,80	22.000

The used filter elements cannot be cleaned and are classified as "Dangerous waste material". They must be disposed according to local laws by authorized Companies.

Verify that the Company you choose has the expertise and authorization to dispose this type of waste material.

# FSD-MSE

## SUCTION FILTERS



### PRESSURE DROP CURVES ( $\Delta P$ )

The Pressure Drop ( $\Delta p$ ) must be lower than 3 kPa (0,03 bar).

FILTER HOUSING PRESSURE DROP  
(mainly depending on the port size)

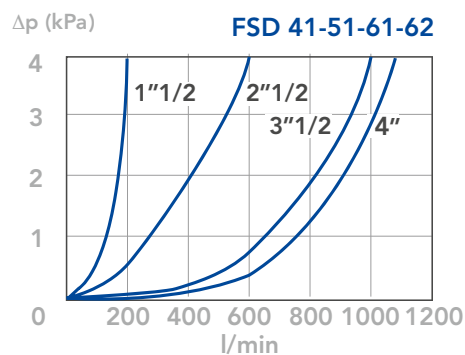
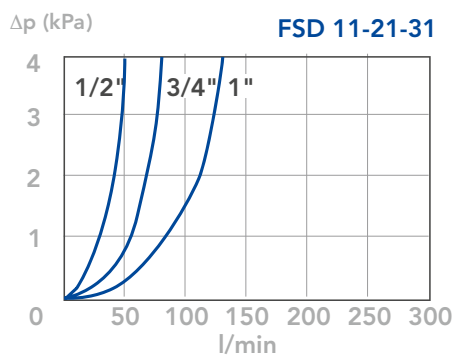

### N.B.

All the curves have been obtained with mineral oil having a kinematic viscosity 30 cSt and specific gravity 0,86 kg/dm<sup>3</sup>; for fluids with different features, please consider the factors described in the first part of this catalogue. All the curves

are obtained from test done at the UFI HYDRAULIC DIVISION Laboratory, according to the specification ISO 3968. In case of discrepancy, please check the contamination level, viscosity and features of the fluid in use.

# FSD-MSE

## SUCTION FILTERS



CLEAN FILTER ELEMENT PRESSURE DROP  
WITH M+ MEDIA  
(depending both on the internal diameter  
of the element and on the filter media)

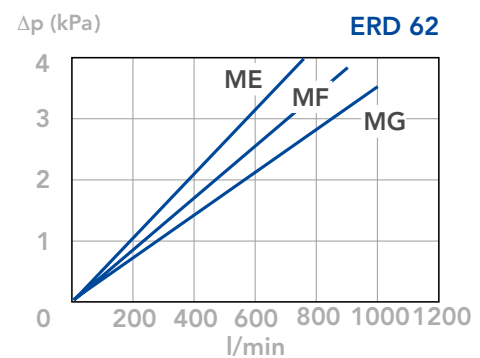
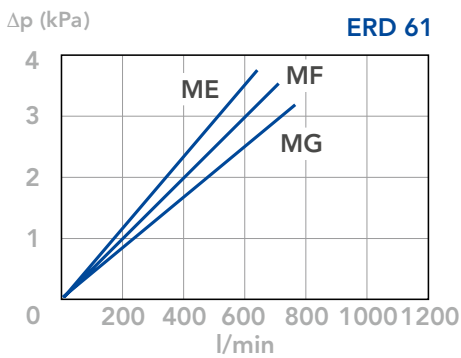
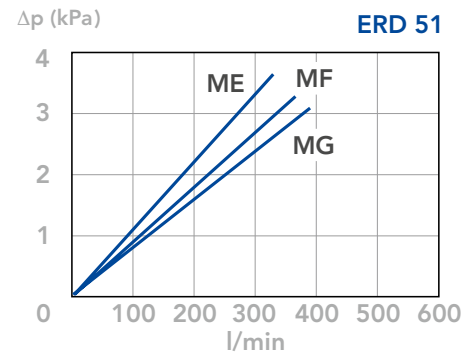
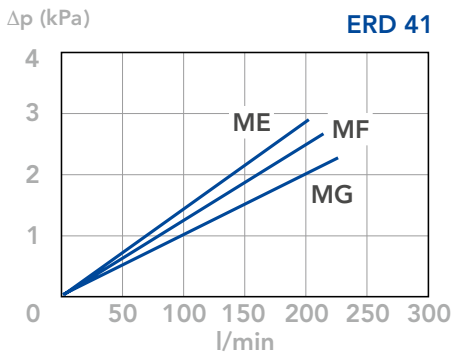
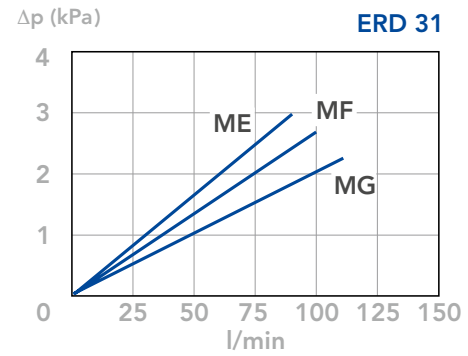
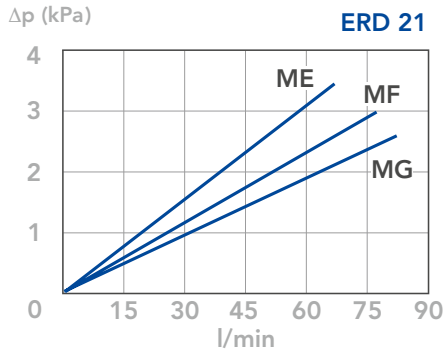
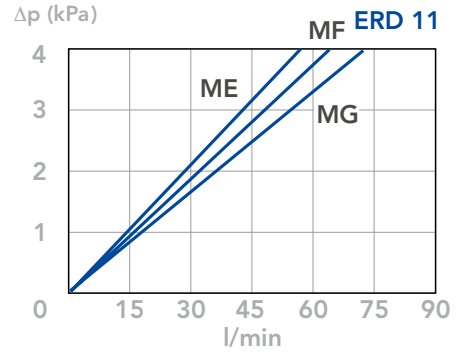

**N.B.**

All the curves have been obtained with mineral oil having a kinematic viscosity 30 cSt and specific gravity 0,86 kg/dm<sup>3</sup>; for fluids with different features, please consider the factors described in the first part of this catalogue. All the curves

are obtained from test done at the UFI HYDRAULIC DIVISION Laboratory, according to the specification ISO 3968. In case of discrepancy, please check the contamination level, viscosity and features of the fluid in use.

# FSD-MSE

## SUCTION FILTERS



### BYPASS VALVE PRESSURE DROP

When selecting the filter size, these curves must be taken into account if it is foreseen that any flow peak is to be absorbed by the bypass valve, it also must be of proper configuration to avoid pressure peaks. The valve pressure drop is directly proportional to fluid specific gravity.

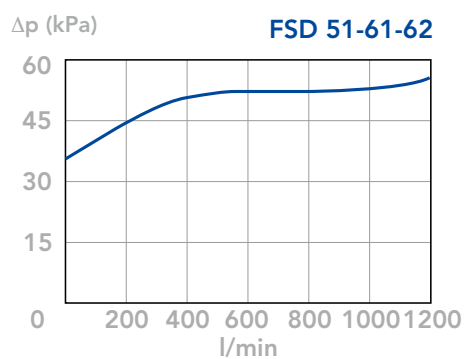
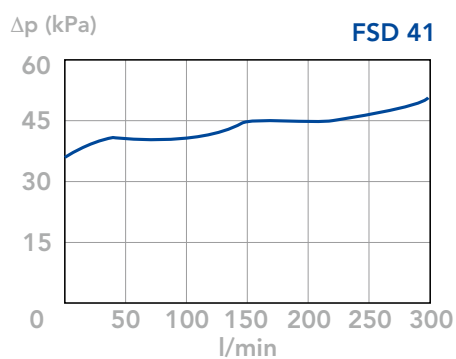
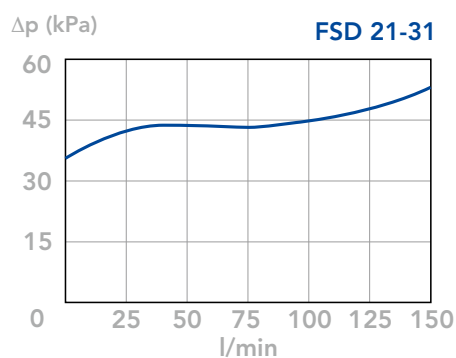
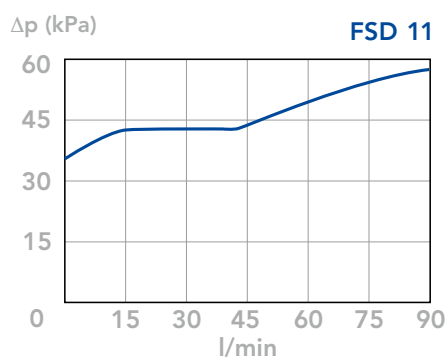

### N.B.

All the curves have been obtained with mineral oil having a kinematic viscosity 30 cSt and specific gravity 0,86 kg/dm<sup>3</sup>; for fluids with different features, please consider the factors described in the first part of this catalogue. All the curves

are obtained from test done at the UFI HYDRAULIC DIVISION Laboratory, according to the specification ISO 3968. In case of discrepancy, please check the contamination level, viscosity and features of the fluid in use.